

Bathroom Product
Specification Guide

Venetian[®]



Introduction

Symphony's bathroom ranges have been specifically designed to meet the needs of today's customers. Manufactured from top quality materials and hard wearing components, the cabinets will retain their good looks and efficient operation throughout their life when properly installed and used normally.

CONTENTS

Accessories	12	Countertops	11	Platform Spacer Panel	11
Additional items	13	Dimensions	03	Plinth and Accessories	10-11
Base Units	05	General Information	04	Ravello	14
Bath End Panels	08	Handles	02	Reduced Depth Base Units – Space Solutions	06
Bath Bulkheads	08	High Wall Units	07	Steel Glazed Feature Doors	07-08
Blender Panels	09	Infill Panels/Pilasters/Shelving	10	Wall Mirrors/Mirror Shelves/ Glass Shelves	11
Corner Posts	09	Low Wall Units/Tall Units	06		
Cornice/Pelmet	10	Lindo Furniture Modules	15		

All dimensions in the specification guide are in millimetres. The depth given is nominal depth including frontal. The height given excludes plinth, which is not supplied with unit.

HANDLES

Range	Door Description	Colour	Cabinet	Handle Code	Handle Description
Tahiti	PVC Wrapped Flat Panel	Gloss White Gloss Latte Oak	White, Pearwood Oak	Choice 29 Choice 41 Choice 51	Nickel Pebble Knob Wenge & Brushed Chrome 'D' Handle Flat Square Chrome Knob
Arctic	PVC Wrapped Saponetta	Gloss White	White	Choice 53	Chrome 'D' Handle
Sargasso	PVC Wrapped Shaker	Pearwood White	Pearwood White	Choice 27 Choice 53	Curved Chrome Bar Handle Chrome 'D' Handle
Ionian	PVC Wrapped Saponetta	Pearwood Oak	Pearwood Oak	Choice 42 Choice 52	Pear Chrome 'D' Handle Chrome Wave Handle
Sicily	PVC Wrapped Flat Panel	Gloss Red	Pear	Choice 49	Chrome Wedge Handle
Mauritius	PVC Wrapped Square Frame with Tongue & Grooved Centre	White Pearwood	White Pearwood	Choice 27 Choice 28	Curved Chrome Bar Handle Grey Crackle Knob
Caribbean	PVC Wrapped Square Framed Stepped Edged Door	Gloss White	White	Choice 4	Granite/Chrome Knob
Ashmore	Timber Shaker	Pearwood	Pearwood	Choice 42	Pear/Chrome 'D' Handle
Zanzibar	Foil wrapped MDF post formed door	Wisconsin	Wisconsin	Choice 55	Satin Nickel Square Knob
Fresca	Gloss slab door with integrated handle	Gloss Latte Gloss White	Wisconsin White	Choice 47	Integrated Matt Chrome Scoop Handle
Java	Foil wrapped MDF Shaker style door	Wisconsin	Wisconsin	Choice 54	Concave Satin Nickel Handle
Shaker White	Gloss white shaker style door	Gloss White	White	Choice 26	Nickel Contoured Bar Handle
Lindo	Modular Furniture	Gloss White, Oak	White, Oak	Choice 56 Choice 57 Choice 51	Large Chrome Bar Handle (suitable for all drawer modules) Small Chrome Bar Handle (suitable for all door modules and the 500mm Deep Drawer Module) Flat Square Chrome Knob (suitable for all module types)

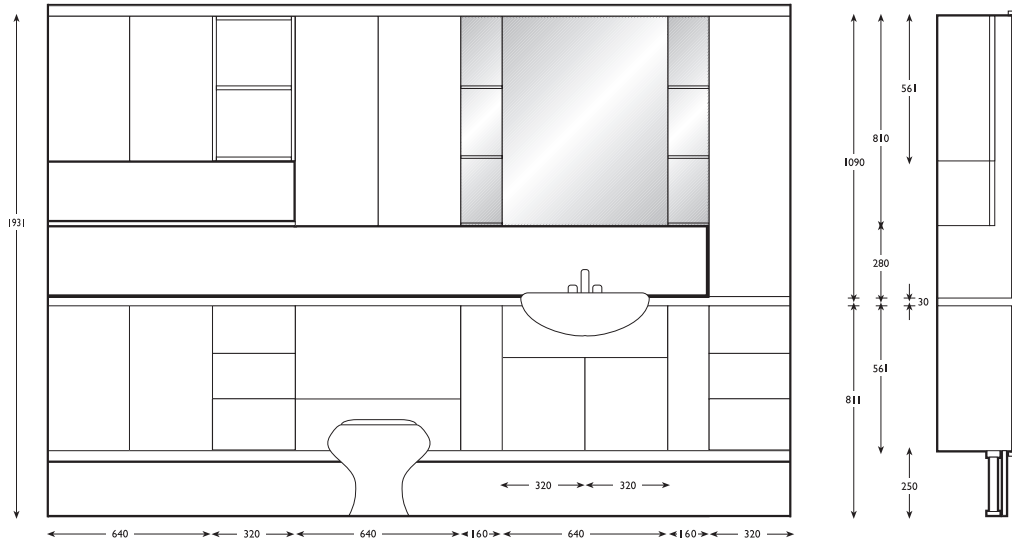

BASIN UNITS

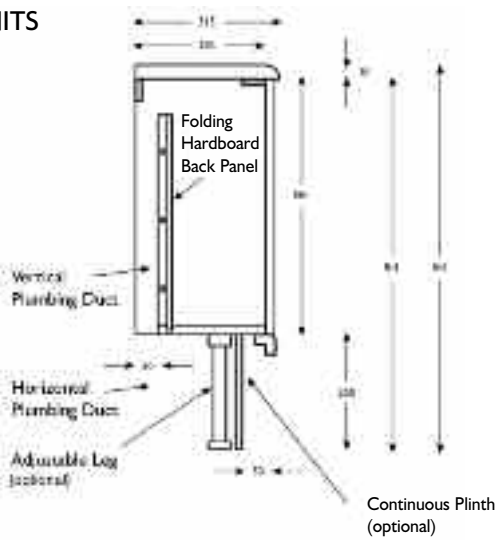

BASE UNITS

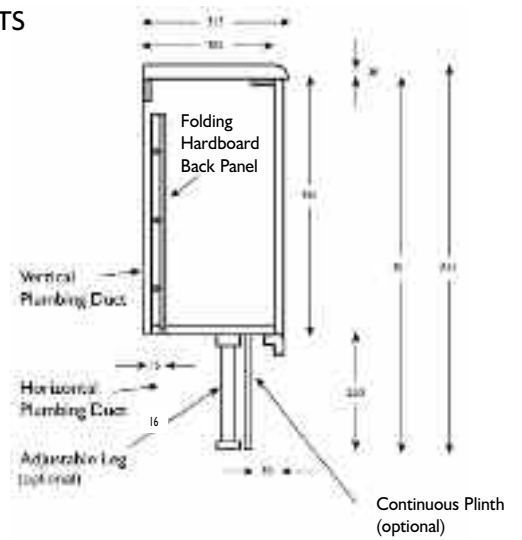

PLANNING GUIDE

Side bath bulkheads

The Side Bath Bulkheads are designed to extend a run of units.

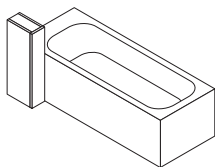

Back bath bulkhead

The Back Bath Bulkhead is designed for cutting to the required size on site and is supplied with a white MFC fascia panel for tiling on site.

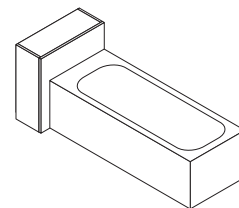

CORNER ARRANGEMENTS

Base units

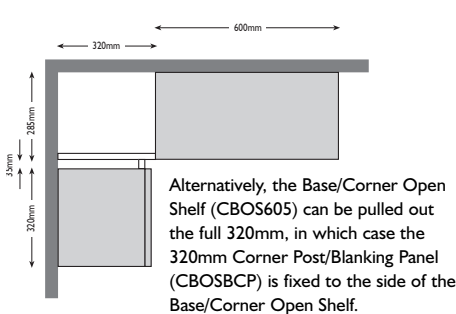
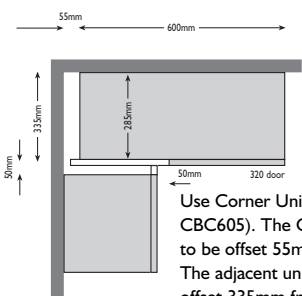

Wall units

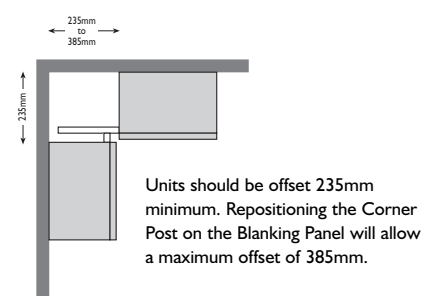

CONSTRUCTION

CABINETS

Manufactured from 15mm high density melamine faced particle board. Cam & dowel construction.

HINGES

All metal 110° clip on type with three way adjustment. Fully concealed. Soft close action.

WALL BRACKETS

Concealed, three way adjustable hanging bracket.

DRAWERS

3-sided removable drawer system. Metal drawer box construction, solid bottom. Full adjustment on drawer fronts to allow full alignment. Soft close action. Fully extendable.

ADJUSTABLE LEGS

Base unit support leg creates ample height for all wastes and services.

MIRRORS

All mirrors are on 15mm backboards in compliance with BS7449. Mirrors are 4mm glass, polished all round.

GLASS SHELVES

All glass shelves are 6mm, polished all round.

COMPATIBILITY

The range is compatible with all major back to wall sanitaryware products.

INSTALLATION GUIDE

ALWAYS CHECK FOR ELECTRICAL WIRES, WATER PIPES OR OTHER SERVICES BEFORE DRILLING.

BASE UNITS

Set height for base units at 811mm on wall above lowest point. Plumb and secure firmly through back rail and brackets. Adjust leg for base support. Continue adding adjoining units, screwing or bolting together and fixing as above.

WALL HUNG BASE UNITS

Set height for base units at 811mm on wall above lowest point. Firmly screw brackets to wall and use adjustment to level. Secure with additional fixings through back rail and brackets. Continue adding adjoining units, screwing or bolting together and fixing as above.

WALL UNITS

Set height for wall units at 1931mm on wall above lowest point. Firmly screw brackets to wall and use adjustment to level. Secure with additional fixings through back support rail or bracket. Continue adding adjoining units, screwing or bolting together and fixing as above.

IMPORTANT

All units should be assembled and fitted using instructions and installation guidelines provided. Any screws and other fixings used must be suitable to support the units, when loaded, into the material they are to be fitted. When using hanging brackets, if a firm fixing cannot be achieved, we **STRONGLY** recommend the use of adjustable support legs.

INSTALLATION SEQUENCE

1. All hot & cold services 'T' off at appropriate positions
2. Locate waste outlets according to the plan
3. Fix base units to the wall
4. Fit sanitaryware
5. Fit countertops
6. Fit wall/dresser cupboards where appropriate
7. Connect and check plumbing
8. Fit continuous plinth if used, scribing as necessary

BASE UNITS

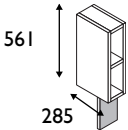
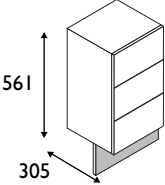
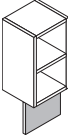
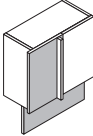
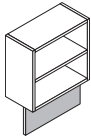
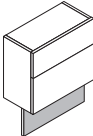
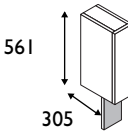
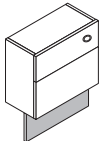
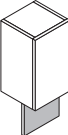
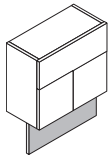
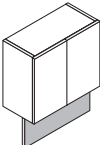
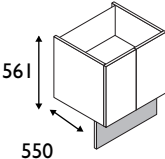
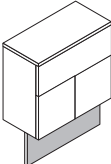
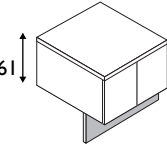
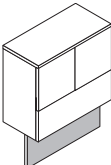
Description	Width	Code	Description	Width	Code
Base Open Shelf One Shelf 	160	BOS165	Drawer Base Three drawers 	320	3DP325
Base Open Shelf One Shelf 	320	BOS325	Corner Unit 	600	CBC605
Base/Corner Open Shelf By using the hinge conversion kit (detailed on page 15) this unit can be converted to a Corner Open Shelf Unit 	600	CBOS605	WC Cupboard Two fixed panels (This unit cannot be wall hung) 	500 600 640	WCC505 WCC605 WCC645
Base Cupboard One door, one shelf 	160	BC165	Push Button WC Cupboard Two fixed panels, dual flush concealed cistern 	500 600 640	WCCDPB505 WCCDPB605 WCCDPB645
Base Cupboard One door, one shelf, accepts linen baskets 	320	BC325	Semi-Recessed Basin One fixed panel, two doors 	600 640 800	SRBC605 SRBC645 SRBC805
Base Cupboard Two doors, one shelf 	600 640	BC605 BC645	Deep Vanity Basin Two doors, one shelf (This unit cannot be wall hung) 	640	DVBC645
Deep Drawer Storage - Top Two doors, one shelf 	600	BCTD605	Reduced Height Vanity Unit (This unit cannot be wall hung) 	640	DVBC603
Deep Drawer Storage - Bottom Two doors, one shelf 	600	BCBD605			

REDUCED DEPTH BASE UNITS - SPACE SOLUTIONS

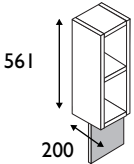
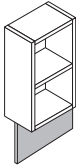
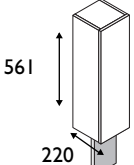
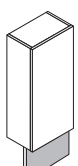
Description	Width	Code
Base Open Shelf Unit One Shelf 	160	BOS1625
Base Open Shelf One Shelf 	320	BOS3225
Single Base Unit One door, one shelf 	160	BC1625
Single Base Unit One door, one shelf 	320	BC3225

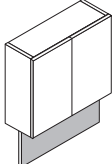
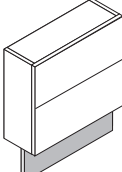
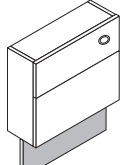
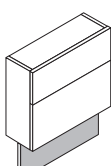

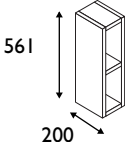
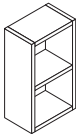
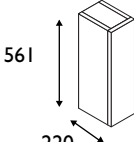

Description	Width	Code
Double Base Unit Two doors, one shelf 	600 640	BC6025 BC6425
WC Cupboard Two fixed panels (This unit cannot be wall hung) 	500 600 640	WCC5025 WCC6025 WCC6425
WC Cupboard Push Button Two fixed panels and dual flush concealed cistern 	500 600 640	WCCDPB5025 WCCDPB6025 WCCDPB6425
Semi-Recessed Basin One fixed panel, two doors 	600 640	SRBC6025 SRBC6425

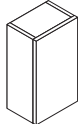
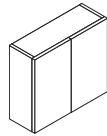
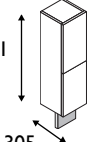
LOW WALL UNITS/TALL UNITS

Description	Width	Code
Low Wall Open Shelf One shelf 	160	LWOS165
Low Wall Open Shelf One shelf 	320	LWOS325
Low Wall Cupboard One door, one shelf 	160	LWC165

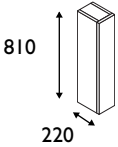
Description	Width	Code
Low Wall Cupboard One door, one shelf 	320	LWC325
Low Wall Cupboard Two doors, one shelf 	600 640	LWC605 LWC645
Tall Storage Cupboard 	320	TSC3216

HIGH WALL UNITS

Description	Width	Code
High Wall Cupboard One door, two shelves 	160	HWC168
High Wall Cupboard One door, two shelves 	320	HWC328
Mirrored High Wall Cupboard (Supplied with handle) 	320	HWCM328
Brushed Steel Mirrored Wall Cupboard 	320	HWCM328SL
Glazed High Wall Cupboard*† (Caribbean has ranged door) 	320	HWCG328

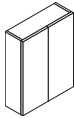
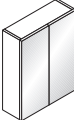
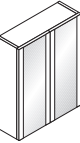
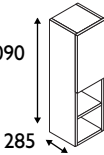
Description	Width	Code
High Wall Cupboard Two doors, two shelves 	600 640	HWC608 HWC648
Mirrored High Wall Cupboard (Supplied with handles) 	640	HWCM648
Brushed Steel Mirrored Wall Cupboard 	640	HWCM648SL
Dresser Unit One door, One shelf 	320	DC33210

* Tahiti, Sargasso, Sicily, Ashmore and Ionian are available in aluminium effect design only.
 † Not available in Mauritius.

STEEL GLAZED FEATURE DOORS

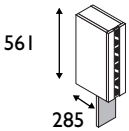
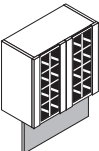
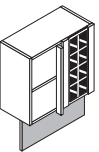
Description	Width	Code
Base Cupboard One door, one shelf 	160 320	BC165SL BC325SL
Double Base Cupboard Two doors, one shelf 	600 640	BC605SL BC645SL
Corner Unit 	600	CBC605SL

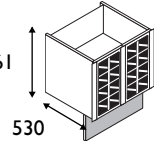
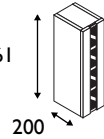
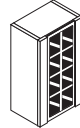
Description	Width	Code
Deep Vanity Basin Two doors, one shelf 	640	DVBC645SL
Low Wall Cupboard One door, one shelf 	160	LWC165SL
Low Wall Cupboard One door, one shelf 	320	LWC325SL

STEEL GLAZED FEATURE DOORS

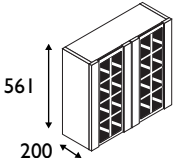
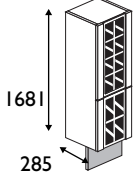
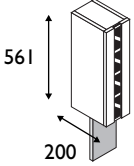
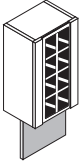
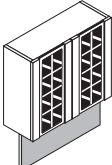
Description	Width	Code
Low Wall Cupboard Two doors, one shelf 	600 640	LWC605SL LWC645SL
Tall Storage Cupboard One door, one shelf 	320	TSC3216SL
Reduced Depth Base Cupboard One door, one shelf 	160	BC1625SL
Reduced Depth Base Cupboard One door, one shelf 	320	BC3225SL
Reduced Depth Double Base Cupboard Two doors, one shelf 	600 640	BC6025SL BC6425SL

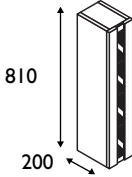
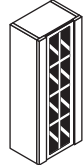
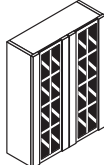
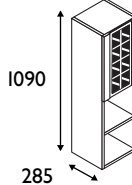
Description	Width	Code
High Wall Cupboard One door, two shelves 	160	HWC168SL
High Wall Cupboard One door, two shelves 	320	HWC328SL
High Wall Cupboard Two doors, two shelves 	500 600 640	HWC508SL HWC608SL HWC648SL
Dresser Unit One door, one shelf 	320	DCI3210SL

BATH BULKHEADS

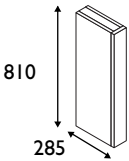
Description	Width	Code
Side Bath Bulkhead Available in Zanzibar, Tahiti, Arctic, Shaker White, Fresca, Ionian, Sargasso, Sicily, Java, Caribbean 	80	BB88

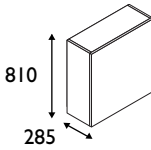

Description	Width	Code
Back Bath Bulkhead With MFC panel for tiling. Available in Zanzibar, Tahiti, Arctic, Shaker White, Fresca, Ionian, Sargasso, Sicily, Java, Caribbean 	800	BB808

BATH END PANELS

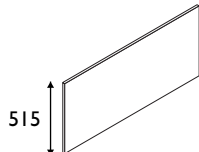
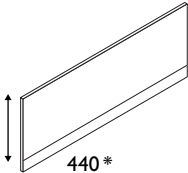
Description	Width	Code
Bath End Panel Available in Tahiti, Latte, Shaker White, Fresca Latte, Ionian Pear, Sargasso, Caribbean, Maritius 	685 750	BEP615 BEP715
Bath End Panel/Plinth Available in Ashmore, Sicily, Tahiti Oak, Ionian Oak, Wisconsin (Supplied as 2 items, including plinth) 	685 750 850	BEP644 BEP744 BEP844

Description	Width	Code
Bath Side Panel Available in Tahiti, Latte, Shaker White, Fresca Latte, Ionian Pear, Sargasso, Caribbean, Maritius 	1690 1800	BSP1615 BSP1815
Bath Side Panel/Plinth Available in Ashmore, Sicily, Tahiti Oak, Ionian Oak, Wisconsin (Supplied as 2 items, including plinth) 	1690 1800	BSP1644 BSP1844



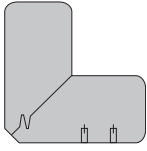
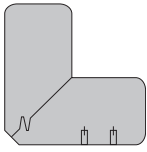

CORNER POSTS

		Width	Depth	Height	Code
Base Corner Post/ Blanking Panel		35	320 (adj)	561	CBOBCP
Corner Post Low Wall/ Blanking Panel		35	200 (adj)	561	CPOST561
Corner Post High Wall/ Blanking Panel		35	200 (adj)	810	CPOST810
Base Solid Corner Post (available in White, Latte, Gloss White, Pear, Ice Blue, Gloss Red, Pear Timber, Oak)		50 50	50 50	561 561	CPOSTBSW CPOSTBSL (Steel)
High Wall Solid Corner Post (available in White, Latte, Gloss White, Pear, Ice Blue, Gloss Red, Pear Timber, Oak)		50 50	50 50	801 801	CPOSTHW CPOSTHWSL (Steel)

Available in Shaker White, Fresca White, Tahiti White, Tahiti Latte, Arctic and Caribbean only. **REPLACEMENT END PANELS**

Description	Height	Code	Description	Height	Code
Base Blender	561	BCBP	Dresser Blender	1090	DCBP
Semi-Recessed Blender Panel	561	SRBCBP	Tall Storage Cupboard Blender	1681	TSCBP
Low Wall Blender	561	LWCBP	Vanity Blender	561	DVBCBP
High Wall Blender	810	HWCBP			

INFILL PANELS/PILASTERS/SHELVING

Description		Width	Depth	Height	Code
Base/Low Wall Infill Panel Carcase Colour		-	200	561	IP25
Base/High Wall Infill Panel Carcase Colour		- -	200 200	810 1090	IP281 IP210
Pilaster Kit Available in White, Gloss White, Pear and Cherry		50 50	- -	561 810	PK55 PK58
22mm Luxury Shelving/ Framing		2600 2600 2600	220 305 650	- - -	SHPANEL26220 (Oak) SHPANEL2622B (Pear, Oak) SHPANEL2662B (Pear)

CORNICE/PELMET

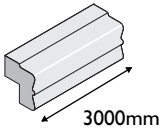
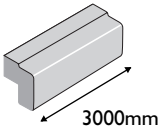
Description		Width	Code	Description		Width	Code
Cornice/Pelmet/ Low Level Rail* White		-	CORBA	Contemporary Cornice/Pelmet/ Low Level Rail* White, Pear, Latte, Gloss Red, Pear Timber, Oak		-	CORBA

* For Mauritius use COR30BA for Cornice and PEL30BA for Pelmet

PLINTH

Description		Width	Code	Continued		Width	Code	
Continuous Plinth/ Midway Shelf		2400	PLINTH2400WH (White)	Continuous Plinth/ Midway Shelf		2400	PLINTH24009R (Latte)	
		2400	PLINTH2400GW (Gloss White)				2400	PLINTH2400LO (Oak)
		2400	PLINTH2400EP (Pear)					

PLINTH ACCESSORIES

Description	Width	Code	Description	Width	Code
Plinth Seal Clear	2800	PLINTHS	Plinth Connector Pear, White, Oak, Wisconsin	250	BRKPLINTH25

PLATFORM SPACER PANEL

Description	Width	Depth	Height	Code
Platform Spacer Panel (matched to carcase colour)	160	285	561	PSP165











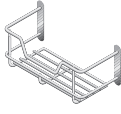

WALL MIRRORS/MIRROR SHELVES/GLASS SHELVES

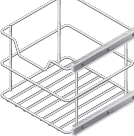
Description	Size	Code	Description	Size	Code
Wall Mirror	600W x 560H 600W x 810H 640W x 810H 800W x 810H	WM566 WM608 WM648 WM808	Glass Shelves	600W x 200L 640W x 200L	GLSHELF600 GLSHELF640
Open Mirror Shelves	160W x 810H 320W x 810H	OMS168 OMS328	Brushed Steel Mirror	600W x 810H 640W x 810H	WM608SL WM648SL

COUNTERTOPS - 30MM THICK

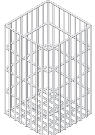
Description	Length	Code	Description	Length	Code
Bullnose Countertops/Flyovers	1000 1500 2000 3000	CT103 CT153 CT203 CT303	Lift-out Cistern Lid Cut out size 430mm x 180mm	470	CT42WC
Bullnose Countertops for Deep Vanity Basin	2000 645	CT205 CT65	Reduced Depth Countertops	2000	CT202

ACCESSORIES

Description		Code	Description		Code
Drop Down Laundry Basket To fit 320mm base unit		LAUNDBASKCX (Chrome)	Medicine Chest To fit inside unit 220mm Width x 243mm Height x 182mm Depth		MEDCHEST
Door Mounted Tidy Rack To fit 320mm base unit		DOORRACKCX (Chrome)	Hinge Conversion Kit For Base/Corner Open Shelf CBOS605		CBOSCK
Two Tier Pull Out Basket To fit 320mm base unit		PBASKDCX (Chrome)	Halogen Downlighters Pack of 2		HALOLIGHTCH (Chrome) HALOLIGHTBR (Brass)
Single Tier Pull Out Basket To fit 320mm base unit		PBASKSCX (Chrome)	Downlighter Bulb		HALOBULBBA
Swing Bin To fit 320mm & 640mm Base Cupboard		SWINGBINBA (White)	Cornice Light Pack of 2 & transformer		CORLIGHTCH (Chrome)
Toilet Roll Holder For use with Platform Spacer Panel		TRHCX (Chrome)	IP Regulated Recessed Light		RECESSLIGHT
Sit-in Linen Basket Use with 320mm Base Cupboard		LINENBASK (White)	IP Regulated Overarm Light		OVERARMLIGHT
Shelving Brackets Nickel		BRKDECSHB	Towel Rail		TR (White) TRCX (Chrome)
Shelving Brackets Chrome		BRKDECSHBCX			

ADDITIONAL ITEMS

Description	Width	Depth	Height	Code
Semi-Recessed Basin Cupboard Door	300	–	361	KDRSRB303
	320	–	361	KDRSRB323
	396	–	361	KDR5RB403
Drawer Front	320	–	184	KDWDF318
Base/Wall Cupboard Door	160	–	561	KDRBLW165
	300	–	561	KDRLW305
Base/Wall/Dresser Cupboard Door	320	–	561	KDRBL325
Tall Wall Cupboard Door	160	–	810	KDRHW168
	320	–	810	KDRHWD328
	300	–	810	KDRHW308
Tall Storage Cupboard Door	320	–	1118	KDRTS3211
Glazed Door*††	320	–	810	KDRHWG328
WC/Basin Panel	500	–	200	KWCBDBP50
	600	–	200	KWCBDBP60
	640	–	200	KWCBDBP64
	800	–	200	KWCBDBP80
WC Top Panel	500	–	361	KWCTP50
	600	–	361	KWCTP60
	640	–	361	KWCTP64

* Tahiti, Sargasso, Sicily, Ashmore and Ionian are available in aluminium effect design only.

† Not available in Tahiti, Sargasso, Ionian, Caribbean and Mauritius.

†† Not available in Mauritius.

RAVELLO WENGE OR OAK

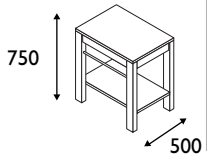
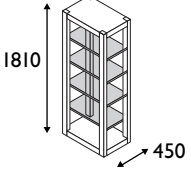
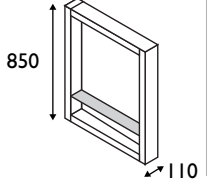
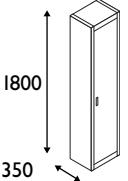
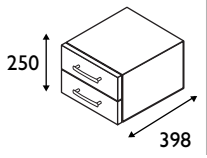
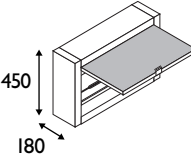
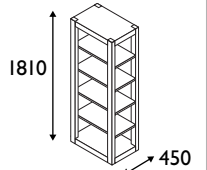
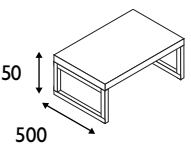
Description	Width	Code	Description	Width	Code
Vanity Table* (Wenge or Oak)		700 VT707FS	Shelf Unit* with glass shelves (Wenge or Oak)		700 OGLSHFS
Framed Mirror (Wenge or Oak)		700 WMF857FS	Tall Storage Cupboard (Wenge or Oak)		400 TALLSTOREFS
Chest of Drawers (Wenge or Oak)		343 2DC3525FS	Lift up Vanity Mirror (Wenge or Oak)		700 LIFTVANMIRFS
Shelf Unit* with wood effect shelves (Wenge or Oak)		700 OSHFS	Vanity Shelf (brackets included) (Wenge or Oak)		700 VANSHBRKFS

*Height for vanity table and shelf unit includes adjustable legs at 10mm
Ravello Oak co-ordinates with Tahiti Oak and Ionian Oak

LINDO BATHROOM FURNITURE MODULES GLOSS WHITE OR OAK

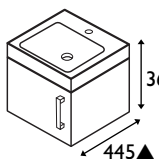
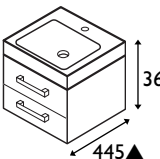
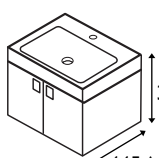
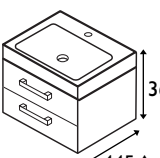
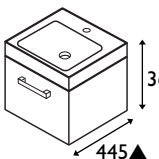
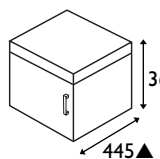
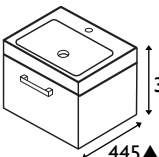
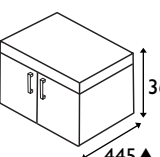
Description	Width	Code	Description	Width	Code
Single Door Basin Module (Gloss White or Oak)		500 MOD1DOOR5BAS	2 Drawer Basin Module* (Gloss White or Oak)		500 MOD2DRW5BAS
Double Door Basin Module (Gloss White or Oak)		600 MOD2DOOR6BAS	2 Drawer Basin Module* (Gloss White or Oak)		500 MOD2DRW6BAS
Deep Drawer Basin Module (Gloss White or Oak)		500 MODDPDRW5BAS	Single Door Module* (Gloss White or Oak)		500 MODDOORS
Deep Drawer Basin Module (Gloss White or Oak)		600 MODDPDRW6BAS	Double Door Module* (Gloss White or Oak)		600 MOD2DOOR6

* Please note that on two drawer units the top drawer is sink/drawer
▲ Nominal depth excluding frontals
† Height not including countertop (30mm) or sink (110mm)
● Does not include countertop, please select desired countertop from choices below

LINDO BATHROOM FURNITURE MODULES GLOSS WHITE OR OAK

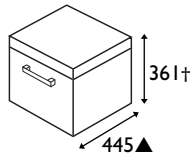
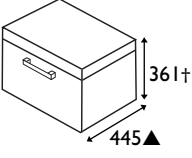
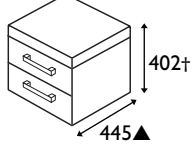
Description	Width	Code
Deep Drawer Module* (Gloss White or Oak) 	500	MODDEEPRW5
Deep Drawer Module* (Gloss White or Oak) 	600	MODDEEPRW6
2 Drawer Module* (Gloss White or Oak) 	500	MOD2DRW5

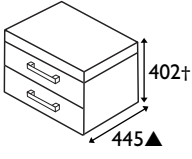
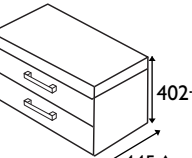
Description	Width	Code
2 Drawer Module* (Gloss White or Oak) 	600	MOD2DRW6
2 Drawer Module* (Gloss White or Oak) 	800	MOD2DRW8

▲ Nominal depth excluding frontals.

*All Lindo Basin Modules include; Marblecast Basin, unit, your choice of handle and an overflow. Waste is not included. Lindo Bathroom Furniture Modules are always supplied as rigid items.

● Does not include countertop, please select desired countertop from choices below.

† Height not including countertop (30mm) or sink (110mm)

LINDO ACCESSORIES GLOSS WHITE OR OAK

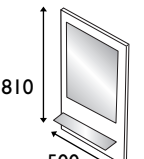
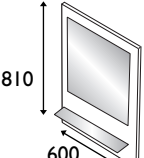
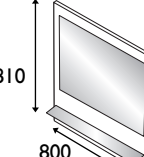
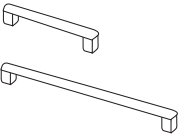
Description	Width	Code
Lindo Wall Mirror (Gloss White or Oak) 	500	WM508MOD
Lindo Wall Mirror (Gloss White or Oak) 	600	WM608MOD
Lindo Wall Mirror (Gloss White or Oak) 	800	WM808MOD
Chrome Handle* 		CHOICE56 (Small*) CHOICE57 (Large*)

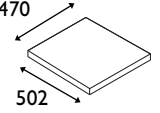
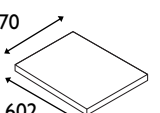
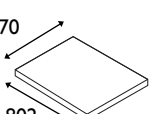
Description	Width	Code
Square Chrome Knob* 		CHOICE51*
Lindo PVC Countertop (Gloss White or Oak) (30mm thickness) 	502	CTMR530
Lindo PVC Countertop (Gloss White or Oak) (30mm thickness) 	602	CTMR630
Lindo PVC Countertop (Gloss White or Oak) (30mm thickness) 	802	CTMR8300

*Handle choice must be specified at point of order. If handle is not specified the standard handle, which is CHOICE 51 will be sent.

The 600mm Double Door Modules are drilled for the Small Bar handle and all the drawer modules and the 500mm Single Door Modules are drilled for the Large Bar handle.