

# Additional Units Brochure 2010

---

Creating the perfect living space

Symphony<sup>®</sup>

## Designed with you in mind

The Symphony kitchen in your new home has been built to the highest standards by one of the country's largest and most respected manufacturers of quality fitted furniture.

Designed with flair and installed with the greatest attention to detail, we are confident you will be happy with its stylish appearance and durability for many years to come.

However, we're also sure that you'll want your new kitchen to reflect your particular tastes and lifestyle, whilst meeting all your individual requirements.

That's why we offer a wide choice of additional furniture, accessories and decorative features - from wall or base units for

extra space, through to glazed dressers to display your favourite possessions. In addition, there's decorative lighting, wall ends, interior storage... the list is endless. Simply tell us your ideas and we'll help you create the kitchen you want. After all - you're unique, so your kitchen should be too.

When you are ready to order, you can submit your payment in a variety of convenient ways including credit card, debit card or by cheque. Your goods will be delivered direct to your door, fully assembled and ready to fit.

You'll discover a world of choice in these pages - every option in the Symphony kitchen range is illustrated. The diagrams on page 3 show unit dimensions.

When you have read this brochure and decided on the items you would like to order, please take five minutes to read through this checklist to ensure you can give us all the information we need to meet your requirements exactly.

The unit content included in this brochure does not represent our entire product offer. Please contact our Additional Unit Department on 01226 446000 (tel) or 01226 711185 (fax) or email [additionalunits@symphony-group.co.uk](mailto:additionalunits@symphony-group.co.uk) to discuss your requirements in further detail.

## Ordering Checklist

### General

Please ensure that you have:

- the correct measurements
- plot number
- developer's name and site address.

### Ordering Units

Please specify the following when ordering

- range and finish/colour of carcass eg Miami Pear/Pear carcass
- size
- full unit code
- left or right handing
- handle and trim details
- 15mm (white interior) or 18mm (fully colour co-ordinated inside and out) cabinets
- 110° or 170° hinges
- Supra drawerbox (white) or Revo drawerbox (metallic)

Please specify cornice and pelmet style for wall units, e.g. traditional, modern tangent, universal.

Please specify plinth details for base units.

Please indicate if you require any additional interior accessories.

### Ordering Display Units

Please specify the following when ordering:

- range and finish/colour eg Boston White
- full unit code
- gallery rail if applicable
- left or right handing

### Ordering Appliance Housings

When ordering appliance housings, please state the appliance manufacturer's name and the appliance number as aperture sizes vary.

### Ordering Worktops

Please specify the following (in mm):

- style/colour eg Riverside Grey
- thickness
- width
- length

Symphony, Pen Hill Estate, Park Spring Road, Barnsley, S72 7EZ Tel: 01226 446000 Fax: 01226 711185

In keeping with our policy of continuous product development, we reserve the right to change colours, designs, materials, descriptions or methods of manufacture. Such changes can be made without notice and without incurring any liability. Nothing in this publication should be considered to be part of any contract. Natural wood is used in some of our ranges. As a natural material, wood reflects the endless variety of grains and textures found in nature and such variances can be expected in any selection of timber-fronted units. Timbers, particularly cherry, mellow when exposed to sunlight, so a colour change can be expected.

# Elevations

## 2100mm

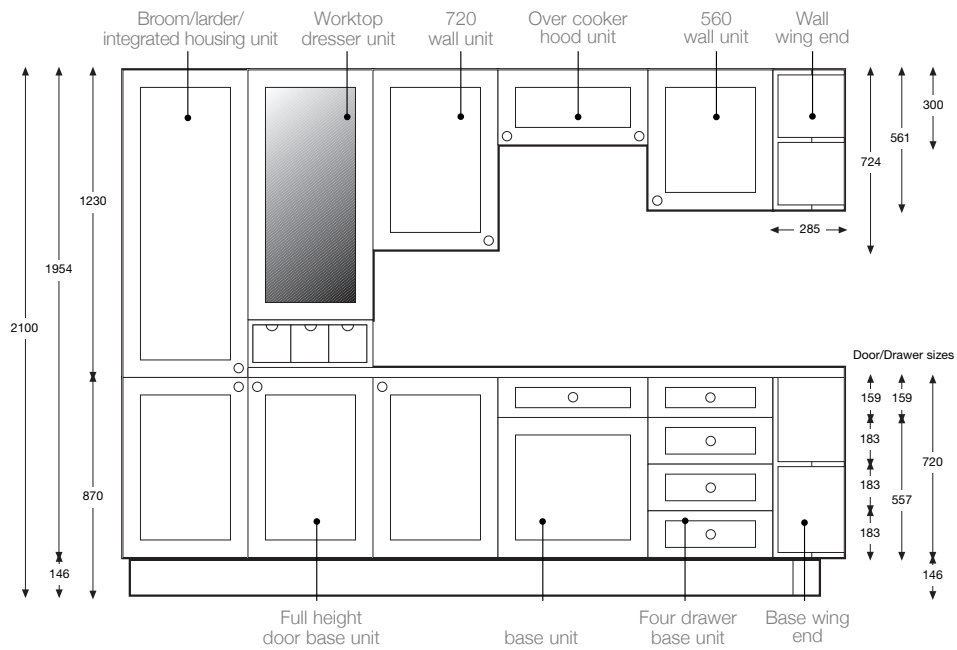

## 2276mm (18mm Excel only)

NB: Base cabinet height to underside of worktop is 870mm. Actual base unit cabinet depth is 570mm. (600mm with worktop.) Actual wall unit cabinet depth is 285mm.

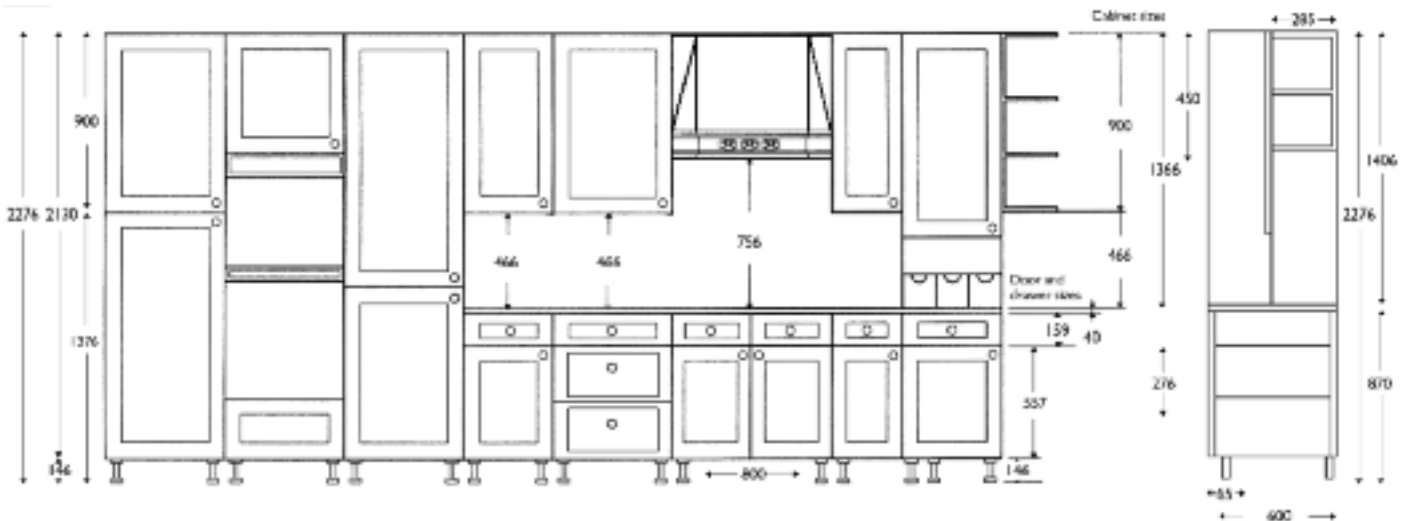

# Specifications

## Corner Base Units

The Symphony corner post allows product ranges with protruding handles to be offset by 30mm in order to avoid possible clashing of drawer handles in a corner. The corner post automatically spaces out the units to the correct size across Dimension A. However the fitter must remember to position the corner unit (as appropriate) from the wall.

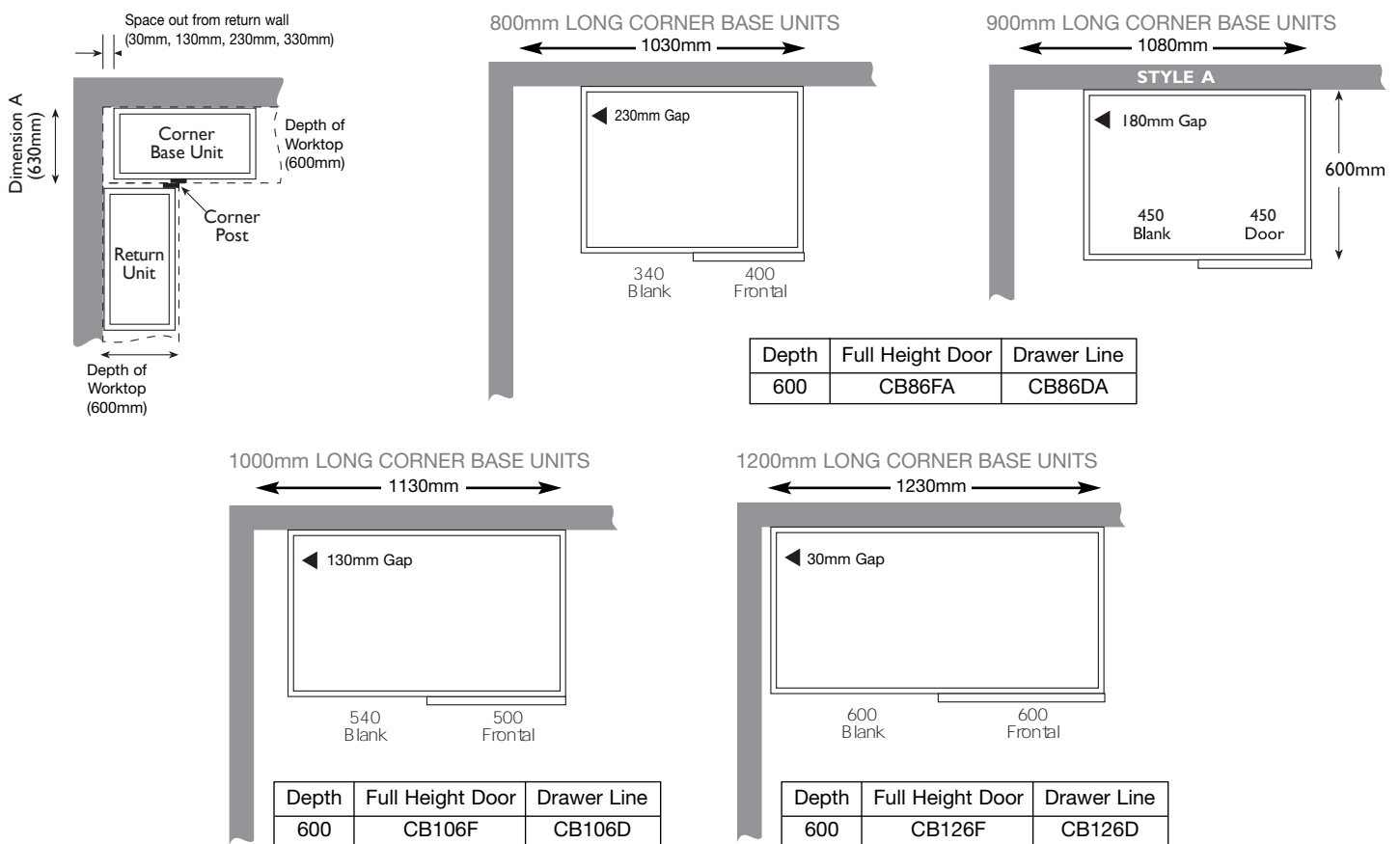

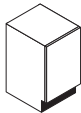
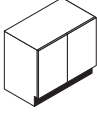

Please contact our Customer Service Department for details of other styles available.

## Full Height Door Base Units

DESCRIPTION	WIDTH	DEPTH	HEIGHT	CODE
<b>Single Base Unit</b> One door, one shelf 	300	570	870	BU36F
	400	570	870	BU46F
	450	570	870	BU456F
	500	570	870	BU56F
	600	570	870	BU66F
<b>Double Base Unit</b> Two doors, one shelf 	800	570	870	BU86F
	900	570	870	BU96F
	1000	570	870	BU106F
	1200	570	870	BU126F

All dimensions in millimetres.

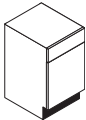
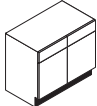
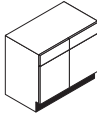
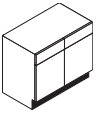
## Drawer Line Base Units

DESCRIPTION	WIDTH	DEPTH	HEIGHT	CODE
<b>Single Base Unit</b> One door, one drawer, one shelf 	300 400 450 500 600	570 570 570 570 570	870 870 870 870 870	BU36D BU46D BU456D BU56D BU66D
<b>Double Base Unit</b> Two doors, two drawers, one shelf 	800 900 1000 1200	570 570 570 570	870 870 870 870	BU86D BU96F BU106D BU126D
<b>Double Sink Base Unit</b> One dummy drawer, one working drawer, two doors, one shelf 	1000 1200	570 570	870 870	SU106D SU126D
<b>Double Sink Base Unit</b> Two dummy drawers, two doors, one shelf 	1000 1200	570 570	870 870	SU106DAI SU126DAI
<b>Single Hob Base Unit</b> One door, one shelf, one dummy drawer 	600	570	870	BU66DDD

## Drawer Units

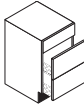

DESCRIPTION	WIDTH	DEPTH	HEIGHT	CODE
<b>Four Drawer Base Unit</b> 	400 500 600	570 570 570	870 870 870	DU46D DU56D DU66D
<b>Pan Drawer Base Unit</b> Two pull-out drawers, one drawer 	600 800 1000	570 570 570	870 870 870	PD66D3 PD86D3* PD106D3*

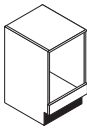
## Base Oven Housings

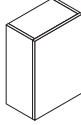
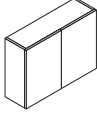
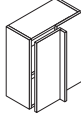

DESCRIPTION	WIDTH	DEPTH	HEIGHT	CODE
<b>Base Oven Housing</b> Supplied with 120mm fascia 	600 900  600	570 570  570	870 870  870	BOH66 KBOH96 (supplied flat pack with metallic fascia) BOH66D (supplied flat pack with drawer)

\*Available as Revo Drawer only in 18mm  
 All dimensions in millimetres.

## 561mm Wall Units

DESCRIPTION	WIDTH	DEPTH	HEIGHT	CODE
<b>Single Wall Unit</b> One door, one shelf 	300	285	561	WU356
	400	285	561	WU456
	450	285	561	WU4556
	500	285	561	WU556
	600	285	561	WU656
<b>Double Wall Unit</b> Two doors, one shelf 	800	285	561	WU856
	900	285	561	WU956
	1000	285	561	WU1056
<b>Corner Wall Unit</b> One door, one shelf, 170° hinges. Blank end for corner returns 	600	285	561	CWU656
<b>Diagonal Corner Wall Unit (400 Door)</b> One door, one shelf, 90° hinges. Not suitable for use as a terminating unit or alone 	630	630	561	DWU656

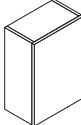
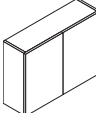
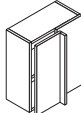
## 724mm Wall Units

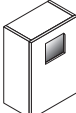
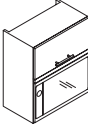





DESCRIPTION	WIDTH	DEPTH	HEIGHT	CODE
<b>Single Wall Unit</b> One door 	300	285	724	WU372
	400	285	724	WU472
	450	285	724	WU4572
	500	285	724	WU572
	600	285	724	WU672
<b>Double Wall Unit</b> Two doors 	800	285	724	WU872
	900	285	724	WU972
	1000	285	724	WU1072
<b>Corner Wall Unit</b> One door, 170° hinges 	600	285	724	CWU672
<b>Diagonal Corner Wall Unit (400 Door)</b> One door, 90° hinges. Not suitable for use as a terminating unit or alone 	630	630	724	DWU672
<b>Glazed Wall Unit*</b> One glazed door 	400 500	285 285	724 724	GDU472 GDU572
<b>Feature Wall Unit</b> 	500	285	724	PIWU572 Pierced - Aspen
<b>Microwave Wall Unit</b> 406 x 564 Max Aperture 	600	330	724	MWU672

A selection of 900mm wall units are available with the 18mm cabinet specification. Please ask for details.

All dimensions in millimetres.

\*Styles of glazed unit vary according to range.

## Metallic Framed Glazed Units

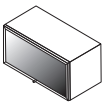
DESCRIPTION		WIDTH	DEPTH	HEIGHT	CODE
<b>Single Wall Unit</b>		400 500	285 285	724 724	GDU472SL GDU572SL
<b>Diagonal Wall Unit</b> (400 door)		630	630	724	GDWU672SL
<b>Peninsular Wall Unit</b>		500	270	724	GPWU572SL
<b>Worktop Dresser Unit - Three Spice Drawers</b>		500	285	1190	WDU512ASL
<b>Worktop Dresser Unit - Single Spice Drawer</b>		500	285	1190	WDU512BSL
<b>Pan Drawer Unit</b> Three pull-out drawers		800	570	870	PD86D3SL
<b>Glazed Cooker Hood</b>		400 500 600 800 1000	285 285 285 285 285	300 300 300 300 300	OCH43SL OCH53SL OCH63SL OCH83SL OCH103SL

## Mid Height Units (18mm Cabinet)

DESCRIPTION		WIDTH	DEPTH	HEIGHT	CODE
<b>Deep Pan Unit</b> 4 working drawers		600	570	1381	PD66D4
<b>Larder Unit</b>		500 600	570 570	1381 1381	LU5613 LU6613
<b>Single Oven Housing</b>		600	570	1381	SOH6613
<b>Single Oven &amp; Microwave Housing</b>		600	570	1381	SOH6613A
<b>Double Oven Housing</b>		600	570	1381	DOH6613
<b>Appliance Housing</b>		600	570	1381	IF6613
<b>Microwave or Coffee Machine Housing</b>		600	570	1381	MOH6613D3
<b>Tambour Larder Unit</b>		500	570	1381	TLU5613SL

A selection of 900mm Wall Units and 1366mm dresser units are available with the 18mm cabinet specification. Please ask for details.

## Larder & Broom Units



DESCRIPTION	WIDTH	DEPTH	HEIGHT	CODE	
<b>Larder Unit</b> Two doors, four shelves 	1228mm door	300	285	2100	LU33 <sup>s</sup>
		300	570	2100	LU36
	720mm door	500	570	2100	LU56
		600	570	2100	LU66
<b>Broom Unit</b> Two doors, three shelves 	1228mm door	300	570	2100	BR36
		500	570	2100	BR56
	720mm door	600	570	2100	BR66
<b>Pull-Out Larder Unit</b> 	1228mm door	300	570	2100	PL36
	720mm door	300	570	2100	WPL36 (soft close)

Symphony can supply integrated housings to accommodate a wide selection of built-in appliances. For appliances not supplied by Symphony, please make sure sizes are checked before ordering. The appliance manufacturer and the model number must be specified when ordering. Units can be hinged left or right. If not specified, integrated fridge freezer housings will be supplied right hand hinged and oven housings left hand hinged.

**IMPORTANT:** Symphony appliance housings are vented through the plinth. Please check the appliance manufacturer's instructions as to the venting requirements for any particular appliance. All appliances must be fitted strictly in accordance with the manufacturer's instructions.

<sup>s</sup> available in 18mm Excel only

## Oven Housings

DESCRIPTION	WIDTH	DEPTH	HEIGHT	APERTURE HEIGHT	CODE	
<b>Microwave &amp; Oven Housing</b> 	450mm door	600	570	2100	Top: 459 Lower: 595	OH661A
		600	570	2100	1180 (minus shelf) Max	OH661B
	296mm Pull-Out drawer	600	570	2100	Top: 484 Lower: 595	OH661C
		600	570	2100	1133 (minus shelf) Max	OH661D
<b>Microwave &amp; Oven Housing</b> 	450mm door	600	570	2100	997 Max	OH662A
		600	570	2100	1042 Max	OH662B
		600	570	2100	Top: 355 Lower: 595	OH662C
	450mm Pull-Out drawer	600	570	2100	Top: 303 Lower: 595	OH662D
		600	570	2100	Top: 330 Lower: 595	OH662E
<b>Double Oven Housing</b> 	450mm door	600	570	2100	890 Max	OH663A
		600	570	2100	865 Max	OH663B
	557mm door	600	570	2100	817 Max	OH663C

2276mm tall units are available for use with 900mm wall units on the 18mm cabinet specification. Please ask for details.

All dimensions in millimetres.



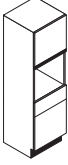
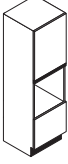
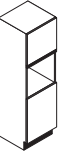
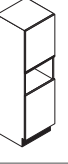
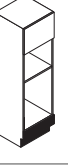
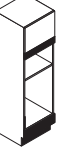

## Oven Housings

DESCRIPTION	WIDTH	DEPTH	HEIGHT	APERTURE HEIGHT	CODE
<b>Single Oven or Microwave Housing</b>  <p>557mm door 159mm drawer 557mm door</p>	600 600	570 570	2100 2100	595 Max 547 Max	OH664A OH664B
<b>Single Oven or Microwave Housing</b>  <p>720mm door 557mm door</p>	600 600	570 570	2100 2100	595 Max 547 Max	OH665A OH665B
<b>Single Oven or Microwave Housing</b>  <p>557mm door 720mm door</p>	600 600	570 570	2100 2100	595 Max 547 Max	OH666A OH666B
<b>Microwave Housing</b>  <p>720mm door 720mm door</p>	600 600 600	570 570 570	2100 2100 2100	457 Max 384 Max 360 Max	OH667A OH667B OH667C
<b>Double Oven and Microwave Housing</b>  <p>450mm door 120mm fascia</p>	600	570	2100	Top: 467 Lower: 890	OH668A
<b>Double Oven and Microwave Housing</b>  <p>450mm door 72mm fascia 120mm fascia</p>	600	570	2100	Top: 395 Lower: 890	OH668B

## Compact Appliance Housings

DESCRIPTION	WIDTH	DEPTH	HEIGHT	APERTURE HEIGHT	CODE
<b>Double Oven and Microwave Housing</b>  <p>296mm flap 72mm fascia pull-out drawer 720mm door</p>	600	570	2100	Top: 296 Lower: 720	OH669A
<b>Double Oven and Microwave Housing</b>  <p>296mm flap 72mm fascia 72mm fascia 720mm door</p>	600	570	2100	Top: 296 Lower: 720	OH669B

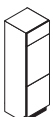
## Fridge Freezer Housings





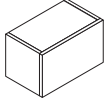
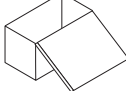
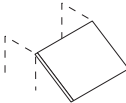

DESCRIPTION	WIDTH	DEPTH	HEIGHT	CODE
<b>One appliance behind top door one appliance behind bottom door</b>  1018mm door 930mm door	600	570	2100	IF66A
<b>One appliance behind bottom door</b>  720mm door 1228mm door	600	570	2100	IF66B
<b>One appliance behind middle door</b> (Hinged to top)  296mm flap 930mm door 720mm door	600	570	2100	IF66C
<b>One appliance behind top and bottom door</b>  1228mm door 720mm door	600	570	2100	IF66D

2276mm appliance housings are available for use with 900mm wall units on the 18mm cabinet specification. Please ask for details



## Bridging Units & Canopies

DESCRIPTION	WIDTH	DEPTH	HEIGHT	CODE
<b>Over Cooker Hood Unit</b> 	600	285	300	OCH63
<b>Bridging Unit</b> 	1000	285	280	OCH1028
<b>Door Front for Integrated Cooker Hood</b> 	600		450	DRICASS

## Integrated Appliance Doors

DESCRIPTION	WIDTH	HEIGHT	CODE
<b>Integrated Dishwasher Door</b> (undrilled) 	596	557	DRDL6UDASS
<b>Integrated Full Height Door</b> (undrilled) 	596	720	DRFH6UDASS
<b>Integrated Drawer Line Door</b> (undrilled) 	596	720	IDFD2ASS
<b>Slimline Full Height Dishwasher Door</b> (drilled) 	446 496	720 720	DRFH45ASS DRFH5ASS
<b>Slimline Drawer Line Dishwasher Door</b> (drilled) 	446 496	720 720	IDFD45ASS DRDW5ASS
<b>Integrated dishwasher door</b> 	600	720	DRDW4ASS

## Worktop Dresser Units

DESCRIPTION	WIDTH	DEPTH	HEIGHT	CODE
<b>Three Spice Drawers</b> One glazed door, three glass shelves, three spice drawers 	500	285	1190	WDU512
<b>Single Spice Drawer</b> One glazed door, three glass shelves, one spice drawer 	500	285	1190	WDU512B
<b>Gallery Rail</b> One glazed door, three glass shelves, gallery rail 	500	285	1190	WDU512C





Dresser units are also available with lattice or pierced doors in selected ranges.

1336mm dresser units are available for use with 900mm wall units on the 18mm cabinet specification.

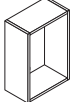
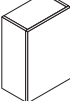

Please ask for details.

All dimensions in millimetres.



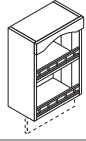
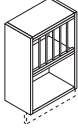
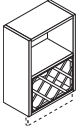
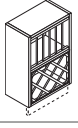

## Boiler Housings

DESCRIPTION	WIDTH	DEPTH	HEIGHT	CODE
<b>Boiler Housing Cabinet</b> Door needs to be ordered separately 	600	400	724	KBHC672 (Supplied flat-pack)
<b>Boiler Housing Unit</b> Door included 	600	400	930	BH69
<b>Dresser Boiler Housing</b> Door included 	600	400	1190	BH12 (Supplied flat-pack 18mm cabinet)
<b>Dresser Boiler Housing</b> Door included 	600	400	1366	BH613 (Supplied flat-pack 18mm cabinet)
<b>Dresser Boiler Housing</b> Door included 	600	400	1560	BH615 (Supplied flat-pack 18mm cabinet)

## Base Open Display Units

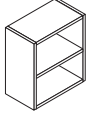
DESCRIPTION	WIDTH	DEPTH	HEIGHT	CODE
<b>Style 1</b> <b>Frieze &amp; Gallery Rail</b> 	500	285	870	ODMB15* (Melamine) ODGB15 (Gloss White)†
<b>Style 8</b> <b>Plate Rack</b> 	500	285	870	ODMB85* (Melamine) ODGB85 (Gloss White)†
<b>Style 9</b> <b>Wine Rack</b> 	500	285	870	ODMB95* (Melamine) ODGB95 (Gloss White)†
<b>Style 10</b> <b>Plate &amp; Wine Rack</b> 	500	285	870	ODMB105* (Melamine) ODGB105 (Gloss White)†
<b>Wicker Basket Unit</b> 	500	570	870	WBU56D

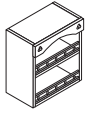
## 561mm Wall Open Display Units

DESCRIPTION	WIDTH	DEPTH	HEIGHT	CODE
<b>Open Wall Unit</b> 	500	285	561	ODU556* (Melamine)
<b>Diagonal Open Wall Unit</b> (Not suitable for use as terminating unit or alone) 	630	630	561	OWU656* (Melamine)
<b>Frieze &amp; Gallery Rail</b> 	500	285	561	ODMW1556* (Melamine)
<b>Gallery Rail</b> 	500	285	561	ODMW7556* (Melamine)



Styles of Display Units vary according to range.

Unless an alternative is specified, the standard rail for the range will be supplied.

† Gloss White units available for Whitchurch only

\*Available in pear, white, blonde oak, walnut, metallic, mezzo and ivory.

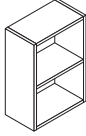
## 724mm Wall Open Display Units

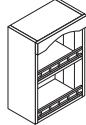
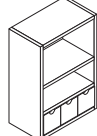
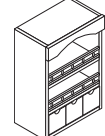
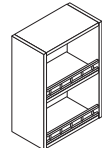
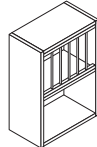
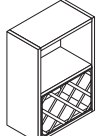
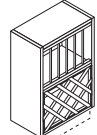
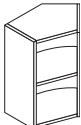
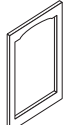
DESCRIPTION	WIDTH	DEPTH	HEIGHT	CODE
<b>Wall Open Unit</b> 	500	285	724	ODU572* (Melamine) ODG572* (Gloss White)†
<b>Wall Open Diagonal Unit</b> Not suitable for use as terminating unit or alone. 18mm Excel includes 2 spacer panels 	630	630	724	OWU672* (Melamine)
<b>Style 1 Frieze &amp; Gallery Rail</b> 	500	285	724	ODMW1572* (Melamine) ODGW1572* (Gloss White)†
<b>Style 3 Three Spice Drawers</b> 	500	285	724	ODMW3572* (Melamine) ODGW3572* (Gloss White)†
<b>Style 5 Frieze, Gallery Rail &amp; Three Spice Drawers</b> 	500	285	724	ODMW5572* (Melamine) ODGW5572* (Gloss White)†
<b>Style 7 Gallery Rail</b> 	500	285	724	ODMW7572* (Melamine) ODGW7572* (Gloss White)†
<b>Style 8 Plate Rack</b> 	500	285	724	ODMW8572* (Melamine) ODGW8572* (Gloss White)†
<b>Style 9 Wine Rack</b> 	500	285	724	ODMW9572* (Melamine) ODGW9572* (Gloss White)†
<b>Style 10 Plate &amp; Wine Rack</b> 	500	285	724	ODMW10572* (Melamine) ODGW10572* (Gloss White)†
<b>Angled Open Wall Unit 22.5°</b> Open unit only - Not available with door 	252	285	724	AWU2272* (Melamine)
<b>Open Display Unit Frame</b> 	496		720	ODUFRAME (Pear, Walnut or Blonde Oak)





Styles of Display Units vary according to range.

Unless an alternative is specified, the standard rail for the range will be supplied.

† Gloss White units available for Whitchurch only

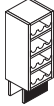
\*Available in pear, white, blonde oak, walnut, metallic, mezzo and ivory.

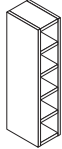
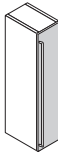
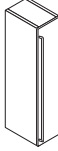
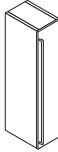
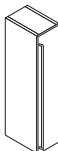
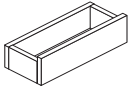
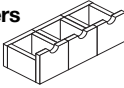
## Wine Rack & Spice Drawers

DESCRIPTION	WIDTH	DEPTH	HEIGHT	CODE
<b>Base Wine Rack</b> 	300	285	724	BWR3* BWRG3 (Gloss White)†
<b>Wall Wine Rack</b> (No plinth) 	300	285	724	WWR372* WWRG372 (Gloss White)†
<b>150mm Spice/Wine Rack</b> 	150	285	724	SPWR15*
<b>Base Unit</b> <b>150mm Pull Out Basket</b> (Stainless steel frontal) 	150	570	870	BU1506BAFXC
<b>Base Unit</b> <b>150mm Pull Out Basket</b> (Aluminium effect frontal) 	150	590	870	BU1506BAFAU
<b>Base Unit</b> <b>150mm hinged</b> (Aluminium effect frontal) 	150	590	870	BU150FAU
<b>Wall Unit</b> <b>150mm hinged</b> (Aluminium effect frontal) 	150	285	724	WU15072AU
<b>Single Spice Drawer</b> (Dresser Units Open Display Units) 	496		159	SPICE 1
<b>Set of Three Spice Drawers</b> (Dresser Units Open Display Units) 	153		140	SPICE 5
<b>Base/Wall Wine Rack</b> <b>Spice Drawers</b> 	112		120	SPICE15*

900mm Wine Rack available for use with 900mm wall units. Please ask for details.



\* For use with 150mm wide spice/wine rack (SPWR15). Spice drawers are available with finger pull fronts in Pearwood, Gloss White, Walnut, White, Mezzo, Blonde Oak, Metallic.

† Gloss White units available for Whitchurch only

\*Available in pear, white, blonde oak, walnut, metallic, mezzo and ivory.

All dimensions in millimetres.

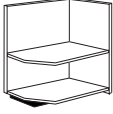
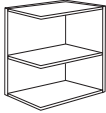
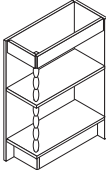
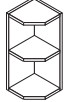
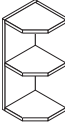
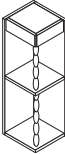
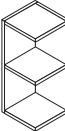
## Wing End Units

DESCRIPTION	WIDTH	DEPTH	HEIGHT	CODE
<b>Base Wing End</b> 	285	570	870	BWE36* (Melamine)
	285	570	870	BWE36G (with Gallery Rail)
	285	570	870	BWG36 (Gloss White)†
	285	570	870	BWGG36 (with Gallery Rail) (Gloss White)†
<b>Modern Base Wing End</b> (Available in Pear, Blonde Oak) 	305	570	870	BWV3622 (Veneered)
<b>Square Base Wing End</b> (Available in Blonde Oak, Walnut) 	305	570	870	BWQ36 (Veneered)
<b>Wall Wing End</b> 	285	285	561	WWE356* (Melamine)
	285	285	561	WWE356G
<b>Wall Wing End</b> 	285	285	724	WWE372* (Melamine)
	285	285	724	WWE372G (with Gallery Rail)
	285	285	724	WWG372 (Gloss White)†
	285	285	724	WWGG372* (with Gallery Rail) (Gloss White)
<b>Square Wall Wing End</b> (Available in Blonde Oak, Walnut) 	305	285	724	WWQ372 (Veneered)
<b>Modern Wall Wing End</b> (Available in Pear, Blonde Oak) 	305	285	724	WWW37222
<b>45° Base Unit</b> (400mm door) 	300	285	870	DBU36D45* DBU36F45*







Styles of Display Units vary according to range.

Unless an alternative is specified, the standard rail for the range will be supplied.

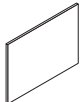
† Gloss White units available for Whitchurch only

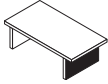

\*Available in pear, white, blonde oak, walnut, metallic, mezzo and ivory.

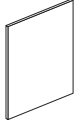
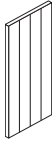
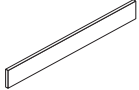
## Filler & Blender Panels





DESCRIPTION	WIDTH	CODE
<b>Breakfast Bar Back Panels</b> (not colour co-ordinated - except Mezzo 18mm only) 	600 x 870 x 18 1200 x 870 x 15 1800 x 870 x 15	MFCBP687P* MFCBP1287P* MFCBP1887P*
<b>Block End Support Panel</b> 	870 x 570 x 15 870 x 570 x 18  650 x 920 x 18	ES687P* ES687PM (Metallic)  ESP6592P*
<b>Tray Platform</b> 	300 x 570	TSP3X6P*
<b>Filler Panels</b> 	720 x 300 x 18 720 x 300 x 18  900 x 300 x 18	BSP372P* BSP372PM (Metallic)  BSP390P*
<b>Flyover Shelf</b> 	2220 x 570  3000 x 285	SHPANEL25* SHPANEL25M (Metallic) SHPANEL30*
<b>700mm Deep Blender Panel</b> 	MFC 700 x 2276 x 18	LUEP723*
<b>Luxury Shelving</b> 	2600 x 305  2600 x 305  2422 x 307	SHPANEL2622 (Pear, White, Blonde Oak, Walnut, Ivory, Metallic or Mezzo Walnut) SHPNL26227P (Wenge) SHPANL2422Z (Gloss Red, White, Black or Latte or Ivory)
<b>Base Unit Framing Panels</b> Available in Pear, White, Blonde Oak, Walnut, Metallic and Mezzo Walnut. Available in Wenge 	2600 x 650	SHPANEL26622 (Pear White, Blonde Oak, Walnut, Metallic or Mezzo Walnut)  SHPNL266227P (Wenge)
<b>Planked Blender Panels</b> Available in Pear and Blonde Oak 	Tall Deep Blender Base Unit Tall Unit Dresser Unit Breakfast Bar Back Wall Unit	PEBLU723 PEBBU6 PEBLU621 PEBWDU312 BP1087PE PEBWU390
<b>Continuous Plinth</b> 	2600 2600 (200 high)  2550 2600 2600	CONPLINTH (MFC) CONPLINTH262 (MFC) (Available in White, Blonde Oak, Pear, Metallic, Walnut, Mezzo and Ivory) CONPLINTHG ((Whitchurch only - Gloss White) CONPLINTHDKO (Havana only - Dark Olive wood) CONPLINTHBC (Dakota only - Black textured) CONPLINT28ZZ (Boston only. Available in Gloss White, Gloss Black, Gloss Red, Gloss Latte and Gloss Ivory)
<b>Decorative Plinth</b> Available in Pear and Blonde Oak  Stainless Steel Effect	3000 3000 3000	DECPLINTH30 DECPLINTH3AU DECPLINTH3SL
<b>Boston Blender Panels</b> Available in Gloss Red, Black, White, Latte and Ivory All 22mm thick	Wall Unit 920 x 307 Tall Unit 2400 x 600 Base Unit 920 x 600 Breakfast Bar 1800 x 920 Tall Deep Blender 700 x 2276 x 18	BWU390ZZ BLU623ZZ BBU692ZZ BBBP1892ZZ LUEPG723

\* MFC available in Pear, White, Blonde Oak, Walnut, Mezzo and Ivory

## Filler & Blender Panels (cont)

DESCRIPTION	SIZE	CODE
<b>Worktop Blender Panels</b> Available in Stardust, Metallic, Snow Spray, Wenge, Palisander, Walnut, Everest Black and Sand. 	650w x 900h 900w x 900h 1000h x 350w 2700h x 150w 2700h x 350w 2700h x 650w	CVB406590 CVB400990 CVB401035 CVB403015 CVB403035 CVB403065
<b>Carcase Matched Blender Panels</b> Available in Pear, Walnut, Mezzo, Metallic, White, Ivory, Blonde Oak, Gloss White 	650w x 900h 900w x 900h 1000h x 350w 2700h x 150w 2700h x 350w 2700h x 650w	CMB406590 CMB400990 CMB401035 CMB402715 CMB402735 CMB402765

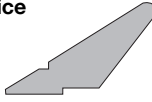

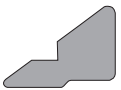
## Cornice & Pelmet

DESCRIPTION	WIDTH	CODE
<b>Traditional Style Cornice</b> 	3000	COR30P (Foil Wrapped - Blonde Oak or Gloss White† and Ivory)
<b>Traditional Style Pelmet</b> 	3000	UPS30P (Foil Wrapped - Blonde Oak or Gloss White† and Ivory)
<b>Modern Tangent Cornice</b> 	3000	CORT30P (Foil Wrapped - White, Blonde Oak, Walnut, Metallic, Mezzo Walnut or Pear)
<b>Modern Tangent Pelmet</b> 	3000	UPST30P (Foil Wrapped - White, Blonde Oak, Walnut, Metallic, Mezzo Walnut or Pear)
<b>Universal Cornice and Pelmet</b> 	3000	CORPEL30 (Pear, Blonde Oak, White, Walnut, Metallic, Mezzo Walnut or Ivory)  CORPEL30ZZ (Boston, Gloss Latte, Gloss Black, Gloss White, Gloss Red or Gloss Ivory)

† Gloss White Cornice and Pelmet suitable for Whitchurch only

## Worktops



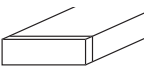

All dimensions in millimetres.

DESCRIPTION	HEIGHT	WIDTH	MAXIMUM LENGTH	CODE
<b>Postformed Worktops</b> 	30 40	500 or 600 500 or 600	3600 3600	PF30 PF40
<b>Double Postformed Worktops</b> 	30 40	665 or 900 665 or 900	3000 3600	DP30 DP40
<b>Postformed Upstands 12mm</b> 	95	12	3000	PFUP3095
<b>PVC Edged Worktops*</b> Metallic, Multiplex, Everest Black, Stardust, Riverside Beige, Riverside Grey, Snow Spray, Sand, Pearwood, Blonde Oak, Palisander, Walnut, Copper Slate, Grey Slate, Light Concrete, Stella Mare, Stella Trattoria and Indian Granite 	40 40	665 900	3600 3600	PV40 DV40



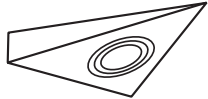
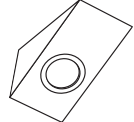

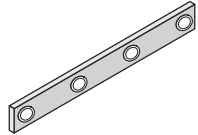

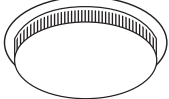

\* Not all edgings are available with all worktop colours. Please ask for details.

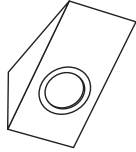
† Gloss White units available for Whitchurch only

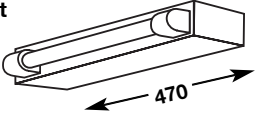
Low Energy LED lighting

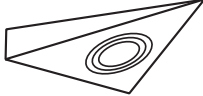
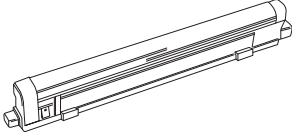

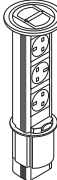
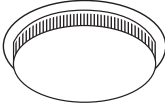



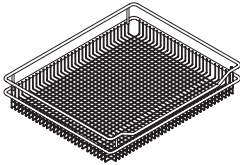

DESCRIPTION	CODE	DESCRIPTION	CODE
<b>LED Delta Light</b> (with Transformer) 	DELTALIGHT (Pack of Two)	<b>LED Wedge Light</b> 	WEDLIGHTLED
<b>LED Downlighter</b> (with Transformer) 	COOLLED1 (Pack of 1)  COOLLED2 (Pack of 2)	<b>Transformer</b> (Driver)	DISTRIBLED6
<b>LED Angled Downlighter</b> 	ANGDLIGHTLED (Pack of 2)	<b>LED Plinth Lights</b> 	PLINTHLED (PACK OF 4)
<b>LED Cornice Light</b> (with Transformer) 	CORLIGHTLED (Pack of 2)	<b>Illuminated Shelves</b> 	SHELFILU5 (500mm) SHELFILU6 (600mm) SHELFILU12 (1200mm)
<b>LED Surface Mounted Downlighter</b> 	SURFACELED		

Accessories

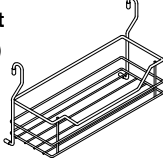
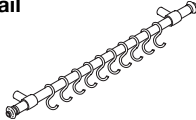
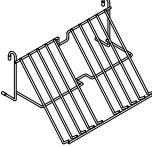
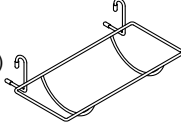
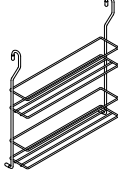
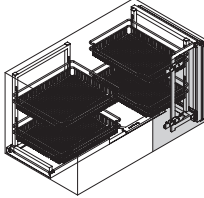
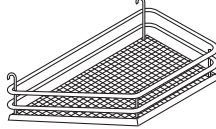
DESCRIPTION	CODE	DESCRIPTION	CODE
<b>Single Wedge Light</b> 	WEDLIGHT1	<b>6 Way Distributor</b> (for use with Surface Light)	DISTRIBUTOR6
<b>Spotlight</b> Available in Chrome 	SLIGHT1	<b>Coollight Downlighter</b> (with Transformer) Available in White, Brass, Chrome 	COOLLIGHT1 (Pack of 1) COOLLIGHT2 (Pack of 2)
<b>Fluorescent Light</b> (use with MAINSLEAD) 	FLIGHT	<b>Chrome Cornice Light</b> (with Transformer) 	CORLIGHTCH (Pack of 2)
<b>Pyramid Light</b> 	DELTALED (Pack of 2)	<b>Mini Fluorescent Light</b> 	MFLIGHT267 (267/6W) MFLIGHT343 (343/8W) MFLIGHT640 (640/18W)
<b>Angled Downlighter</b> 	ANGDLIGHT	<b>Connecting Lead</b> 	CONLEAD500 (595MM) CONLEAD3000 (3000MM)
<b>Pop Up Socket</b> 	POPUCKET	<b>Transformer and Dimmer</b> (for WEDLIGHT20W)	TRANSFORMER
<b>Surface Mounted Fluorescent Light</b> Coloured bulbs Blue, Red and Warm White 	SURFACELIGHT (7 watt) REPBULB7WWH	<b>Transformer</b> (for ANGDLIGHT) 	UNIVTFORMER



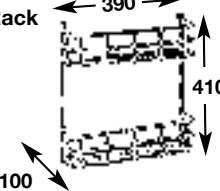
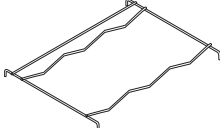
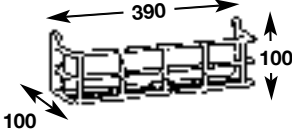
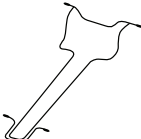

For a full selection of ergonomic solutions contact the additional units department at Symphony.

Accessories



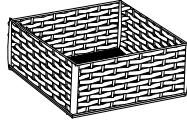
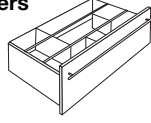

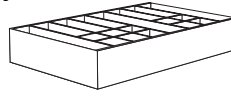
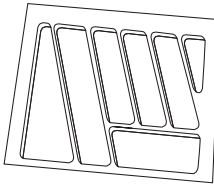
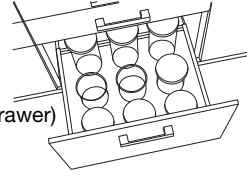
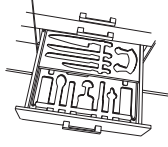
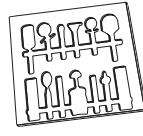
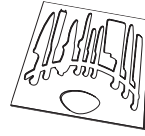
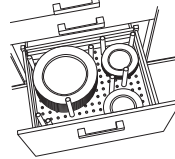
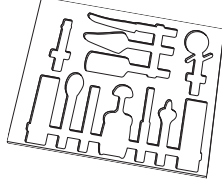
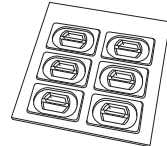
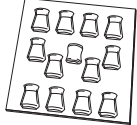
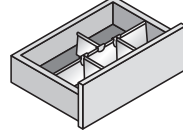
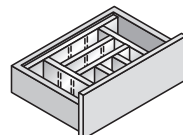
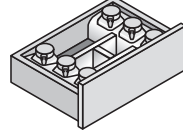
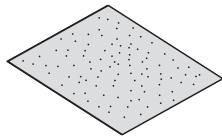
DESCRIPTION	CODE	DESCRIPTION	CODE
<b>Chrome Basket with Runners</b> 	PBASK5CX (450x464mm) PBASK6CX (450x564mm)	<b>Extra Chrome Hooks</b> (For use with midway rail) 	SHOOKCX (12pk)
<b>Chrome Shelf Basket</b> (For use with midway rail) 	SHELFBASKCX (294mm)	<b>Chrome Midway Rail</b> 	MWRAIL10CX (1000mm)
<b>Chrome Cookery Book Support</b> (For use with midway rail) 	CBOOKSUPPCX (315mm)	<b>Chrome Kitchen Roll Holder</b> (For use with midway rail) 	KRHCX (300mm)
<b>Chrome Spice Rack</b> (For use with midway rail) 	SPICERACKCX (294mm)	<b>Magic Corner</b> To be installed in CB106DA/FA or CB106DC/FC 	MCULCX (Left Hand) MCURCX (Right Hand) 2 boxes
<b>45° pull out</b> 	DPLBASK45	<b>Chrome 1/2 Carousel Baskets</b> (for 1000BU with 500 door/1200BU with 600 door only)  850 dia	CAROBASKCH
<b>Pull Down Basket</b> for easy access to wall units 	SPRINGBASKCX		
<b>Chrome 3/4 Carousel</b> (L shape base unit)  700 dia	CAROBASKCX	<b>Chrome Pull-out Larder Baskets</b>  1620	PLUBASKCX
<b>LeMans Pull Out Corner*</b> 	LEMANSCU opposite handing to CBU (1000mm unit 500mm door)	<b>Two Tier Bottle Rack</b>  390, 410, 100	DOORBASKTCH
<b>Wine Rack Insert</b> 	WRSHELF3CX (300mm unit) WRSHELF3CX5 (pack of 5) WRSHELF5CX (500mm unit) WRSHELF5CX5 (pack of 5)	<b>Single Tier Bottle Rack</b>  390, 100, 100	DOORBASKSCH
<b>Wine Glass Rack</b> 	GLASSCOL2 (300mm Cabinet) (Pack of 2)		

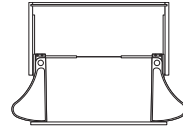
\*To be installed in CB106DA/FA (order separately) for a corner unit with a door on the left hand side order left handing and vice versa for right.

Accessories

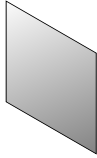
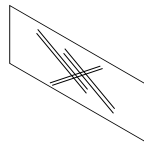
DESCRIPTION	CODE	DESCRIPTION	CODE
<b>Wicker Basket</b> <b>(Pack of 2)</b> (c/w Runners) 	WICKBASK	<b>800 Pan Drawer Dividers</b> 	DWDIVGALL8 (Silver)
<b>Cutlery Tray</b> 	CTRAYSUPR5V (433x420mm) CTRAYSUPR4V (333x420mm) CTRAYSUPR6V (533x420mm)	<b>800 Cutlery Tray</b> (Metallic wide pan drawers) 	CTRAYGALL8SV (Silver)
<b>REVO Cutlery Tray</b> (Standard Drawer) 	CTRAY5PK (500mm) CTRAY6PK (600mm) CTRAY8PK (800mm) CTRAY10PK (1000mm)	<b>REVO Pasta/                      Cereal Store</b> (276mm Deep Drawer) 	PDPASTA6 (600mm)
<b>REVO Utensil Tray                      &amp; Sliding Knife Block</b> (Standard Drawer) 	UTRAY6KNIFE (600mm)	<b>REVO Utensil Tray &amp; Knives</b> (Standard Drawer) 	UTRAY8KNIFE (800mm) UTRAY10KNIFE (1000mm)
<b>REVO Knife Block</b> (Standard Drawer) 	KNIFEBLOCK5 (500mm) KNIFEBLOCK6 (600mm)	<b>REVO Drawer Plate Stack</b> (276mm Deep Drawer) 	PDPLATESTK6 (600mm) PDPLATESTK8 (800mm) PDPLATESTK10 (1000mm)
<b>REVO Utensil Tray</b> (Standard Drawer) 	UTRAY5 (500mm) UTRAY6 (600mm) UTRAY8 (800mm) UTRAY10 (1000mm)	<b>REVO Stainless Steel                      Containers</b> (Standard Drawer) 	CONTAINSL5 (500mm) CONTAINSL6 (600mm)
<b>REVO Herb/Spice Tray</b> (Standard Drawer) 	HERBSPICE5 (500mm) HERBSPICE6 (600mm)	<b>REVO Aluminium Pan                      Drawer Organisers</b> (276mm Deep Drawer) 	DW47ORG6 (600mm) DW47ORG8 (800mm) DW47ORG10 (1000mm)
<b>REVO Aluminium                      Cutlery Inserts</b> (Standard Drawer) 	CTRAYGALL3M (300mm) CTRAYGALL4M (400mm) CTRAYGALL5M (500mm) CTRAYGALL6M (600mm) CTRAYGALL8M (800mm) CTRAYGALL10M (1000mm)	<b>REVO Aluminium                      Jar Organisers</b> (276mm Deep Drawer) 	DW47JAR6 (600mm) DW47JAR8 (800mm) DW47JAR10 (1000mm)
<b>Drawer Mats*</b> To be used with Aluminium Cutlery Inserts 	DWMAT3 (300mm) DWMAT4 (400mm) DWMAT5 (500mm) DWMAT6 (600mm) DWMAT8 (800mm) DWMAT10 (1000mm)	<b>REVO Metallic                      Cutlery Tray</b> 	CTRAYGALL4V (462x310) CTRAYGALL5V (462x410) CTRAYGALL6V (462x510)
		<b>Orgawing</b> (800/1000mm Pan Drawer) 	ORGAWING

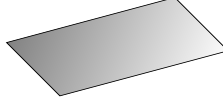
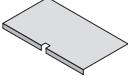
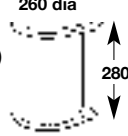
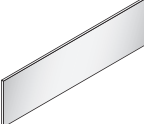
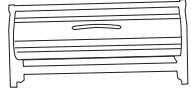
# Accessories

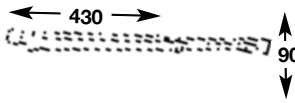
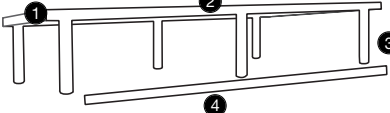
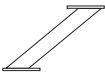
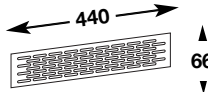
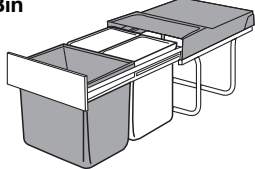
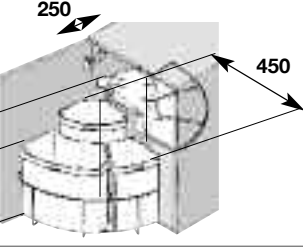
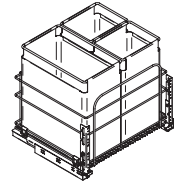
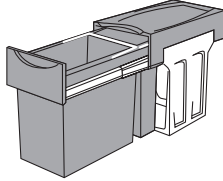
DESCRIPTION	CODE	DESCRIPTION	CODE
<b>Stainless Steel Splashback</b> 	SBACK675 (600w/750h mm) SBACK775 (700w/750h mm) SBACK975 (900w/750h mm)	<b>Glass Shelves (Frosted)</b> 	GLSHELF6F (600 x 247mm) GLSHELF8F (800 x 247mm) GLSHELF10F (1000 x 247mm)
<b>Laminate Splashback</b> Available in Stardust, Snow Spray, Wenge, Walnut, Everest Black, Sand, Riverside Beige, Pearwood, Copper Slate, Lunar Night HD, Lunar White HD, Bella Noche HD, Bella Capri HD 	WTSB24X6 (2440 x 600) WTHDXB24X6 (Hi Def - 2440 x 600) WTSB24X12 (2440 x 1200) WTHDSB24X12 (Hi Def - 2440 x 1200) WTSBACKEND (End Cap) WTSBACKBUT (Butt Joint) WTSBACKCNR (Corner Joint)	<b>Coloured Glass Splashback</b> Available in Bride, Pewter, Ebony and Chalk White 	GLSPLASH675 (600w/750h mm) GLSPLASH975 (900w/750h mm) GLSPLASH1075 (1000w/750h mm)
<b>Sink Liner</b> Please note: 1000 and 800 Sink Liners will not work in corner base units if the corner post is not in the middle of the unit 	SU12LINER(1200mm) SU10LINER(1000mm) SU8LINER(800mm) SU6LINER(600mm) SU5LINER(500mm)	<b>Deluxe Waste Bin 110° hinged door only</b> (will not fit under sink bowl) 	SWINGBINCH (12 Litres) (400mm unit min)
<b>Coloured Glass Upstand</b> Available in Bride, Pewter, Ebony and Chalk White 	GLUP1014 (1000w x 140h mm) pack of 2	<b>Tambour Kit</b> (Metallic Effect) 	TAM513SL
<b>Decorative Shelving Bracket</b> 4 brackets per shelf length 	BRKDECSH	<b>Double Towel Rail</b> 	METALTRAIL
<b>Decorative Leg</b>	ADJCHRLEG	<b>Aluminium Support System</b> 	UNITSUP10AU (1000x600mm) UNITSUP20AU (2000x600mm) UNITSUP6AU (600x600mm)
<b>Worktop Bracket</b> 	WTMOUNTBAR	<b>Aluminium Support System Extras</b>	<ol style="list-style-type: none"> <li>1 UNITSUPENDAU (Pack of 2 ends)</li> <li>2 UNITSUP120AU Island Pack - 880x2000mm use with UNITSUP20AU</li> <li>3 UNITSUPLEGAU (Pack of 2 legs)</li> <li>4 UNITSUPDEC20 (3000mm) Decorative Strip</li> </ol>
<b>Ventilation Grill</b> 	VENTGRILL200	<b>Triple Waste Bin</b> Do not use with 170° hinge 	ECOBIN4 (400mm only) 1 x 18 litres 2 x 8.5 litres
<b>Eco-bin</b> Do not use with 170° hinge 	RECYCLEBIN (500/600mm unit) 1 x 19 litres 1 x 12 litres 1 x 9 litres	<b>60L Eco Bin</b> 	ECOBIN60L (600mm unit only) 1 x 30 litres 2 x 15 litres
<b>Tandem Waste Bin</b> Do not use with 170° hinge 	ECOBIN3 (300mm only) 1 x 20 litre 1 x 10 litre		

Notes

# Symphony<sup>®</sup>

The Symphony Group Plc, Pen Hill Estate, Park Spring Road, Barnsley, South Yorkshire, S72 7EZ

Tel: 01226 446000 Fax: 01226 711185

Email: [enquiries@symphony-group.co.uk](mailto:enquiries@symphony-group.co.uk)

[www.symphony-group.co.uk](http://www.symphony-group.co.uk)

© The Symphony Group PLC October 2010



Printed using wood free paper made from ECF pulp and meeting ISO14001 criteria